

SDI MANUAL OF CONSTRUCTION WITH STEEL DECK



MOC2
2006

TABLE OF CONTENTS	Page
I. PRODUCT DESCRIPTIONS	4
1 General – All Deck Products	4
2 Composite Floor Deck	4
3 Roof Deck	5
4 Cellular Deck	5
5 Form Deck	6
II. APPROVED ERECTION DRAWINGS	12
III. PACKAGING	12
IV. LOADING & SHIPPING	14
V. RECEIVING, UNLOADING, STORAGE & PROTECTION	15
1 Deck Protection Example	16
2 Deck Ordering Check List	17
VI. ERECTION OF DECK & JOB SITE SAFETY	18
1 Alertness	19
2 Lifting	20
3 Fastening & Installing	26
4 Housekeeping	34
VII. DECK DAMAGE & PENETRATIONS	35
1 Roof Deck	35
2 Penetration Example	36
3 Details for Opening Example	37
4 Sump Pans	38
5 Floor Deck	40
6 Cantilevers Example	41
VIII. PLACING CONCRETE	42
IX. SPECIAL CONSIDERATIONS FOR DIAPHRAGMS	45
1 Construction Load Table	45
2 Deck Loading Diagrams	46
3 References	47

SDI NOTICE

The Steel Deck Institute makes no representation or warranty respecting any information contained in this manual, including, but not limited to, the accuracy, completeness, or suitability of such information for any particular purpose or use. The Steel Deck Institute expressly disclaims any and all warranties, expressed or implied. By making this information available, the Steel Deck Institute is not rendering professional services, and assumes no duty or responsibility with respect to any person making use of this information. In addition, neither the Steel Deck Institute nor any of its Members or Associate Members shall be liable for any claim, demand, injury, loss, expense, cost or liability of any kind whatsoever which in any way arises out of or is connected with the use of the information contained in this publication, whether or not such claim, demand, loss, expense, or liability results directly or indirectly from any action or omission of the Steel Deck Institute or any of its Members or Associate Members. Any party using the information contained in this manual assumes all liability arising from such use.



SDI MANUAL OF CONSTRUCTION WITH STEEL DECK

PURPOSE

This manual is intended to be an aide and general guide for the safe and proper erection of steel deck. The objectives are safety, which is always paramount, and providing a good quality job. This manual is not intended to define specific duties or responsibilities of any of the participants involved in doing the work nor is it intended to replace necessary contract documents. Each participant the design professional, the deck manufacturer, the general contractor, the deck erector, the owner, and each individual worker should be aware of their individual responsibilities, as defined in the contract documents, so that the job environment will be as safe as possible and also to produce a good job.

While the information presented in this manual has been prepared in accordance with generally recognized engineering principles and accepted construction practice, it is recommended that it be reviewed by the design professional and the builder for its applicability for any specific job.

ACKNOWLEDGEMENT

This publication is a revision of the original document reflecting changes in construction practices and revisions to OSHA 1926 Subpart R. Since this is a revision of the original manual with the majority of it being reprinted, the SDI would still like to recognize those involved with this original manual. Especially Professor Larry D. Luttrell of West Virginia University (Research Advisor to the SDI) for his review and comments; Mrs. Cheryl Janusz for editing the text; Mr. Merle Nordyke for his excellent cartoons; Mr. John McMahon of the Institute of the Ironworking Industry for his advice; and the members of the Steel Erectors Association of America (SEAA) for their many helpful suggestions.

The SDI Erection Committee

I. PRODUCT DESCRIPTIONS

1. General - All Deck Products

Steel deck is made by cold forming structural grade sheet steel into a repeating pattern of parallel ribs. The strength and stiffness of the panels are a result of the shape of the ribs and the material properties of the steel. Deck lengths can be varied to suit job conditions but, because of shipping considerations, are usually less than 40'. Standard deck width varies with the product used but full sheets are usually 12", 18", 24", 30" or 36". Deck is typically furnished in a standard width with the ends square cut. Any cutting for width, such as at openings or for angular fit, is done at the job site.

Deck is typically attached to the building frame with arc puddle welds, self drilling screws or powder or pneumatically driven pins. Sheet to sheet fastening is done with screws, button punching (crimping), or welds.

2. Composite Floor Deck

After installation and adequate fastening, floor deck serves several purposes. It (a) acts as a working platform (b) stabilizes the frame (c) serves as concrete form for the slab and (d) reinforces the slab to carry the design loads applied during the life of the building. Composite decks are distinguished by the presence of shear connector devices as part of the deck. These devices are designed to mechanically lock the concrete and deck together so that the concrete and the deck work together to carry subsequent floor loads. The shear connector devices can be rolled in embossments, lugs, holes or wires welded to the panels. The deck profile configuration can also be used to interlock concrete and steel.

Composite deck finishes are either galvanized (zinc coated) or phosphatized/painted. Phosphatized/painted deck has a bare (phosphatized) top surface which is the side to be in contact with the concrete. This bare top surface can be expected to develop rust before concrete is placed. The bottom side of the deck has a primer coat of paint. (See the next section on Roof Deck for a description of primer paint.) Galvanized deck has a zinc coating on both sides.

Composite floor deck is normally installed so the panel ends do not overlap on the supporting beams. Shear lugs or profile shape often prevent a tight metal-to-metal fit if panel ends overlap. The air gap caused by overlapping prevents proper fusion with the structural steel when sheet end laps are shear stud welded.

Adequate end bearing of the deck must be obtained as shown on the erection drawings. If bearing is actually less than shown, further investigation is required.

3. Roof Deck

Roof deck is not designed to act compositely with other materials. Roof deck acts alone in transferring horizontal and vertical loads into the building frame. Roof deck rib openings are usually narrower than floor deck rib openings. This provides adequate support of rigid thermal insulation board.

Roof deck is typically installed to endlap approximately 2" over supports. However, it can be butted (or lapped more than 2") to solve field fit problems. Since design professionals frequently use the installed deck system as part of the horizontal bracing system (the deck as a diaphragm), any fastening substitution or change should be approved by the design professional. Continuous perimeter support of the deck is necessary to limit edge deflection in the finished roof and may be required for diaphragm shear transfer.

Standard roof deck finishes are galvanized or primed painted. The standard factory applied paint for roof deck is a primer paint and is not intended to weather for extended time periods. Field painting, touch up of abrasions and deterioration of the primer coat or other protective finishes are the responsibility of the buyer. It is recommended, however, that any field paint be applied over a small test area of the primed deck and tested for compatibility and adhesion prior to proceeding with field painting. Special paint, or paint to be applied over galvanizing, is available on special order but must be adequately described to the manufacturer before bidding.

4. Cellular Deck

Cellular deck is made by attaching a bottom steel sheet to a roof deck or composite floor deck panel. Cellular deck can be used in the same manner as floor deck. Electrical, telephone and computer wires are easily run through the chase created between the deck panel and the bottom sheet.

When used as a part of the electrical distribution system, the cellular deck must be installed so that the ribs line up and create a smooth cell transition at abutting ends. The joint that occurs at butting cell ends must be taped or otherwise protected to prevent concrete from entering the cell. Cell interiors must be free of welding burrs or other sharp intrusions to prevent damage to wires.

When used as roof deck, the bottom flat plate is usually left exposed to view. Care must be maintained during erection to keep good alignment and prevent damage.

PRODUCT DESCRIPTIONS

Cellular deck is sometimes used with the flat plate on the topside to provide a flat walking surface. Installation of deck for this purpose requires special methods for attachment to the frame because the flat plate now on the top can prevent direct access to the deck material that is bearing on the structural steel. It may be advisable to treat the flat top surface to prevent slipping.

Cellular deck is always furnished galvanized or painted over galvanized.

5. Form Deck

Form deck can be any floor or roof deck product used as a concrete form. Connections to the frame are by the same methods used to attach floor and roof deck. Welding washers are recommended when welding metal thickness is less than 0.0280 inches.

Form deck is furnished galvanized, prime painted or uncoated. Galvanized deck must be used for those roof deck systems where form deck is used to carry a lightweight insulating concrete fill.

In a patented, dry installed roof deck assembly, form deck is utilized as the primary load carrying element. This assembly functions as a structural roof deck diaphragm. The assembly may include dry installed thermal insulation placed above either prime painted, field painted galvanized or galvanized and painted steel sections.

Figure 1
ALL DIMENSIONS ARE NOMINAL

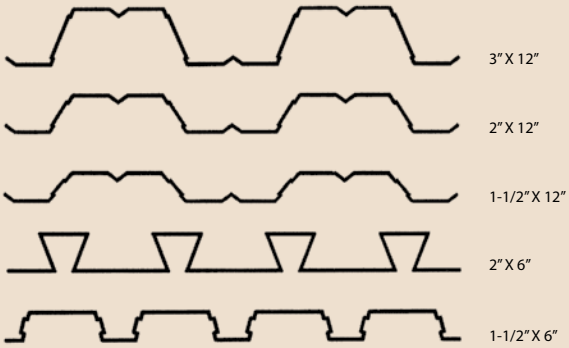

TYPICAL COMPOSITE FLOOR DECK PROFILES

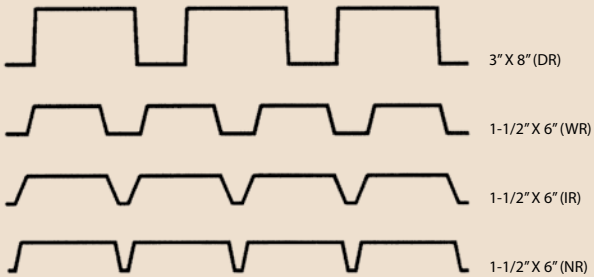

TYPICAL ROOF DECK PROFILES



TYPICAL FORM DECK PROFILES

DECK PROFILES

Figure 1A
All dimensions are nominal.





Composite Floor Deck Profiles	Name	Nominal Thickness Range	Weight Range	Comments
	<p>1 1/2" X 12" 2" X 12" 3" X 12" Composite</p>	<p>.03" to .06"</p>	<p>2 psf to 4 psf</p>	<p>Embossment patterns will vary from manufacturer to manufacturer. Side laps are flat adjustable or button punchable.</p>
	<p>2" X 6" Composite</p>	<p>.03" to .06"</p>	<p>2 psf to 4 psf</p>	<p>Embossment patterns will vary from manufacturer to manufacturer. Side laps are flat adjustable or button punchable.</p>
	<p>1 1/2" X 6" Composite</p>	<p>.03" to .06"</p>	<p>2 psf to 4 psf</p>	<p>Embossment patterns will vary from manufacturer to manufacturer. Side laps are flat adjustable or button punchable.</p>
	<p>3" X 8" Composite</p>	<p>.03" to .06"</p>	<p>2 psf to 4 psf</p>	<p>Embossment patterns will vary from manufacturer to manufacturer. Side laps are flat adjustable or button punchable. This profile is not generally suitable for use with shear studs.</p>

Figure 1B
All dimensions are nominal.

Roof Deck Profiles	Name	Nominal Thickness Range	Weight Range	Comments
 <p>36" OR 30" COVERAGE $k \rightarrow 2\frac{1}{2}" \text{ NOM.}$ $\leftarrow 6" \rightarrow$ $\leftarrow 1\frac{3}{4}" \text{ MIN.} \rightarrow$</p>	1 1/2" X 6" Wide Rib (WR)	.03" to .06"	2 psf to 4 psf	May be referred to as "B" deck. Sidelaps may be flat adjustable or button punchable. Acoustical deck will have perforated webs.
 <p>36" OR 30" COVERAGE $k \rightarrow 1\frac{3}{4}" \text{ NOM.}$ $\leftarrow 6" \rightarrow$ $\leftarrow \frac{1}{2}" \text{ MIN.} \rightarrow$</p>	1 1/2" X 6" Intermediate Rib (IR)	.03" to .06"	2 psf to 4 psf	May be referred to as "F" deck.
 <p>36" OR 30" COVERAGE $k \rightarrow 1" \text{ NOM.}$ $\leftarrow 6" \rightarrow$ $\leftarrow \frac{3}{8}" \text{ MIN.} \rightarrow$</p>	1 1/2" X 6" Narrow Rib (NR)	.03" to .06"	2 psf to 4 psf	May be referred to as "A" deck.
 <p>24" COVERAGE $k \rightarrow 2\frac{3}{4}" \text{ NOM.}$ $\leftarrow 8" \rightarrow$ $\leftarrow 1\frac{1}{2}" \text{ MIN.} \rightarrow$</p>	3" X 8" Deep Rib (DR)	.03" to .06"	2 psf to 4 psf	May be referred to as "N" deck. Sidelaps may be flat adjustable or button punchable. Acoustical deck will have perforated webs.

DECK PROFILES

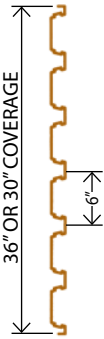
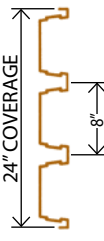
Figure 1C
All dimensions are nominal.

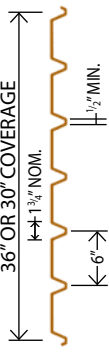
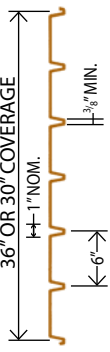
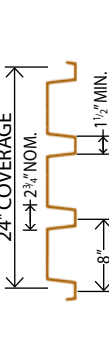





Cellular Floor Deck Profiles	Name	Nominal Thickness Range	Weight Range	Comments
 <p>24" OR 36" COVERAGE</p> <p>12"</p>	3" X 12" Composite Cellular	.03" to .06"	4 psf to 7 psf	Bottom plate may be perforated for acoustical.
 <p>24" OR 36" COVERAGE</p> <p>12"</p>	2" X 12" Composite Cellular	.03" to .06"	4 psf to 7 psf	Bottom plate may be perforated for acoustical.
 <p>24" OR 36" COVERAGE</p> <p>6"</p>	1 1/2" X 6" Composite Cellular	.03" to .06"	4 psf to 7 psf	May also be used as a roof deck. Bottom plate may be perforated for acoustical.
 <p>24" COVERAGE</p> <p>8"</p>	3" X 8" Composite Cellular	.03" to .06"	4 psf to 7 psf	May also be used as a roof deck. Bottom plate may be perforated for acoustical.

Figure 1D
All dimensions are nominal.

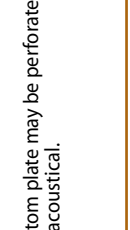
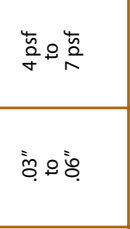
Form Deck Profiles	Name	Nominal Thickness Range	Weight Range	Comments
	9/16" X Varies Form Deck	.014" to .030"	0.8 psf to 1.5 psf	Standard form deck. Used as centering.
	15/16" X Varies Form Deck	.017" to .040"	1.0 psf to 2.0 psf	Heavy duty form deck. Used as centering.
	1-5/16" X Varies Form Deck	.017" to .047"	1.0 psf to 2.8 psf	Extra heavy duty form deck. Used as centering.
	1-1/2" or 2" X Varies Form Deck	.023" to .047"	1.4 psf to 2.8 psf	Super duty form deck. Used as centering.

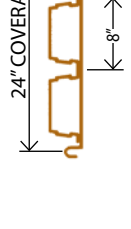
Note: All profiles may be used as roof deck (for a patented assembly)

II. APPROVED ERECTION DRAWINGS

Only those installation drawings that have been stamped "APPROVED FOR CONSTRUCTION" i.e. "FIELD USE" should be used for deck erection.

Prior to beginning deck erection, the erector should review the plans for overall job site orientation. On projects with multiple deck profiles and gages, individual areas should be identified for each type of deck.

All General Notes should be reviewed for special instructions. Drawing sections in particular need to be studied for installation details. The drawings and bundle tags need to be examined for proper bundle placement.

The engineer of record has approved the attachment method and pattern. Therefore, all fastening to the structure and sheet side laps should be carefully followed as shown on the "APPROVED FOR CONSTRUCTION" drawings.

III. PACKAGING

Deck is banded into bundles that can weigh several thousand pounds but the deck bundle weight will be limited to a maximum 4000 pounds for deck to be applied to joists. Deck bundle weights for material to be applied over structural steel frames or other framing systems will be as required to suit job conditions, and to meet safe hoisting, spreading and installation procedures. If heavier or lighter bundles are required because of job conditions, this information must be conveyed to the deck supplier well before production is scheduled. The deck supplier, the erector and the purchaser should all be in agreement about the bundle sizes and weights that are to be delivered to the job.

Tags (see Figure 2) on the bundles may provide some or all of the following information:

1. weight of bundle
2. deck manufacturer's contract number
3. customer name and job name
4. product description gage (thickness), product name, and finish
5. number of pieces, lengths
6. area (on job) that is to receive the bundle
7. bundle number
8. any special notices or storage instructions

Special tags, such as those required by Underwriters Laboratories or Factory Mutual, are applied to the bundle and not to the individual sheets.

Any special markings or other information (as well as special packaging) must be agreed upon prior to fabrication.

Previously agreed upon color coding is often very helpful for gage identification on a multigage project. Color coding may also be agreed upon for other quick identification purposes.

EXAMPLE OF BUNDLE TAG
Figure 2

STEEL DECK FABRICATOR

CONTRACT NO.

CUSTOMER NAME

PROJECT NAME

PROJECT ADDRESS

DECK TYPE, GAGE, FINISH

NUMBER OF PIECES	LENGTH		MARK
	FT.	IN.	
20	27	10.00	334.00
20	25	11.00	311.00
5	25	7.00	307.00
45			

NOTES:

BUNDLE NO

CONTROL NO.

BOM. BUNDLE NO.

X OF X

XXXX-XXX-XXXXX

XX

TRUCK: XX

IV. LOADING AND SHIPPING

Bundle tags show the job area (derrick) where the bundle belongs. The deck manufacturer will sequence deck bundling so that deck will be delivered in a proper (or previously agreed upon) order and be unloaded and hoisted in logical sequences. Erection information should be made available to the deck manufacturer as soon as possible after placing the order so that sequencing can be done during preparation of approval drawings.

All job conditions that will affect shipping (i.e. weight restrictions, staging, special strapping, blocking, tarping) should be determined well in advance of fabrication so that appropriate steps can be taken by the shipper.

The deck manufacturer will load trucks using standard procedures. These procedures may consider the following:

1. Strapping will be secured, preventing blow off or loosening of sheets during transit.
2. Deck bundles may be placed against the trailer or truck bulkhead to prevent forward movement in case of a sudden stop. Note that load distribution may dictate another arrangement.
3. Deck bundles are separated with dunnage (horizontally and vertically) of at least 1½" (more if agreed upon) so that lifting slings can be inserted for unloading.
4. Deck will be loaded with the longest bundles on the bed of the truck to ensure that the load will be balanced.
5. To ensure safe and level loads, every other bundle may be turned on the truck. In all cases the bundle arrangement on the trailer will be made with an effort to provide the greatest stability of the load and to achieve the allowable weight.

During transportation, shock and vibration tends to compress bundles, which can result in slackening of the trailer load binders normally used in the transport of deck. This may cause a dangerous situation; over tightening of the tie downs in anticipation of settling will damage the product. Periodic adjustments and retightening are necessary. Each adjustment should also ensure that the tarps are repositioned to keep the load dry to prevent moisture from affecting the finish.

Unless partial shipments or less than truckload (LTL) shipments are agreed upon, full truckload shipments are standard. Truckloads will be determined by weight and volume. If LTL shipments are used, the deck manufacturer cannot be responsible for any damage caused by rehandling or load transfer between trucking companies.

Receiving

There must be proper access to the structure for the deck delivery. The access must be adequate to support the lifting equipment and the delivery trucks. Lifting equipment must be capable of safely lifting the deck bundles and have sufficient reach to properly place the bundles on the structure.

Unloading

Material should be checked as it is received. Bundles should be counted. The bill of lading should be checked to verify trailer contents. Small packages are sometimes carried inside the tractor. Check to see if all items are present. Any material damages or shortages should be noted on the bill of lading prior to signing for the material and the supplier should be immediately notified.



"KEEP LOAD IN SIGHT UNTIL SAFELY LANDED"

RECEIVING, UNLOADING STORAGE AND PROTECTION

Storage and Protection

If ground storage is needed, the deck bundles should be stored off the ground, with one end elevated to provide drainage. Bundles should be protected against condensation with a ventilated waterproof covering. Bundles should be stacked so that there is no danger of tipping, sliding, rolling, shifting or material damage.

Bundles should be checked for tightness so wind cannot loosen sheets or work the bundles apart. Tightness should be periodically checked and additional securement should be used as needed. Bundles should never be hoisted by the strapping and should always be placed tag side up. It is the position of the Steel Deck Institute that; DECK BUNDLES MUST ALWAYS BE PLACED ON THE FRAME NEAR A MAIN SUPPORTING BEAM AT A COLUMN OR WALL. IN NO CASE, SHOULD THE BUNDLES BE PLACED ON UNBOLTED FRAMES OR UNATTACHED OR UNBRIDGED JOISTS. The structural frame must be properly braced to receive the bundles.

OSHA Federal Register Subpart R 1926.757 does allow some flexibility as to how and when, during the structure's erection process, landing bundles of deck is permitted. This OSHA regulation must be examined by anyone engaged in this activity, such that all criteria is understood and met.

Recommendation for Protecting Deck Bundles at Job Site

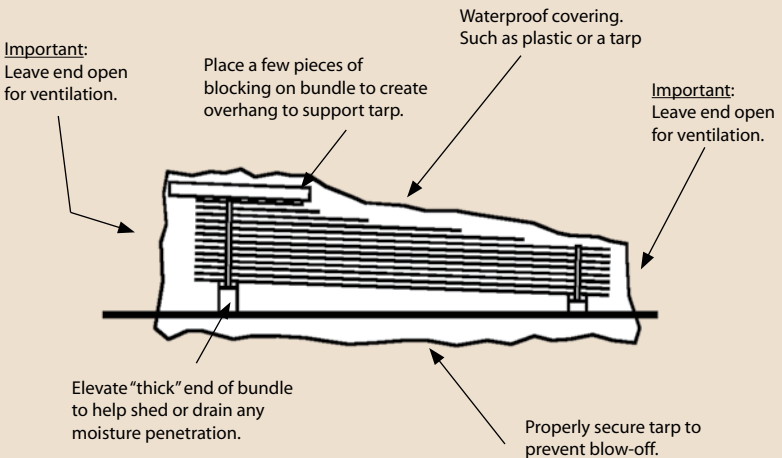

I. Deck Profile

- Wide Rib (WR) - B
- Intermediate Rib (IR) - F Narrow Rib (NR) A
- 3" Deep Rib (3DR) - N Other

II. Deck Type (thickness) – Gage and inches.

- 22 (0.0295")
- 20 (0.0358")
- 18 (0.0474")
- 16 (0.0598")
- Cellular Bottom Plate
- 20 (0.0358")
- 18 (0.0474")
- 16 (0.0598")
- Other - Specify decimal thickness

III. Deck Finish

- Prime Painted Manufacturer's Standard
- G60 Galvanized
- G90 Galvanized
- Prime Paint (manufacturer's standard) over G60
- Galvanizing Uncoated
- Other - Specify in Separate Document

IV. Is Fire Rating Required?

- Yes - Give Appropriate U.L. Design Number and Hours Required or F.M. Number

V. Sheet Length Limits

- None or Specify

VI. Bundle Weight Restrictions

- Not to exceed _____ lbs.
- No Restrictions

VII. Required Space Between Bundles for Hoisting Devices

- Standard 1½"
- Other - Specify

VIII. Special Tagging on Bundles

- U.L. Labels
- F.M. Labels
- Other - Specify

Any special sequencing, timing or other restrictions must be provided to the deck supplier. The deck supplier must be provided a complete and accurate address for shipping.

VI. ERECTION OF DECK AND JOB SITE SAFETY

Serious injury or death can result from failure to familiarize and comply with all applicable safety requirements of federal, state and local regulations and these safety guidelines before erecting steel deck.

OSHA Federal Register Subpart R 1926 issued January 18, 2002 provides specific erection guidelines for typical conditions. However, where employers elect, due to conditions specific to the site, to develop alternate means and methods that provide employee protection, a site specific erection plan shall be developed by a qualified person. OSHA provides guidelines for establishing a site specific erection plan in Appendix A of the OSHA Federal Register Subpart R 1926. The deck manufacturer is not responsible for preparing the "site specific" erection plan. However, deck erection drawings may be helpful to those preparing the plan.

Deck erectors create their own working platform. For the most part these platforms will not have protected edges or protected openings. Erectors must also work on the open steel frame and use ladders or scaffolding to access the work.

Coil ordering practices and manufacturing processes have been established and are being followed so that as shipped deck products will be free of visible liquid lubricants and dry residues will be minimized. The purpose of establishing these practices and processes is to reduce the slipping hazard of the walking surfaces of decking products. For more information on this issue, please refer to the "Steel Coalition Lubricant Task Group Report" dated May 14, 2002. This report is available on the SDI web site.



Alertness

Most deck installations are done on an elevated structure and the danger of falling is always present. Falls may occur at any time and at any location. Alertness is essential. Ladders should be securely tied to the structural frame or the scaffolding. Stairs, if available, should be rigidly attached to the building frame.

Access areas should be specially patrolled to keep them free of equipment, material, and debris.

Deck edges are sharp. Workers should take precautions to protect themselves from sharp edges or projecting corners.

It is very important that the structure be ready to receive the deck. Before deck bundles are placed on the frame, the frame plumbness and connections should be checked. Verify that temporary bracing is in place to keep the frame in a plumb condition until the deck is placed and secured.

**“SHARP EDGES ARE
A CONSTANT THREAT”**



Lifting

Steel joists must be securely attached at their bearing ends and have their bridging completely attached. Verify the structure's capacity to carry the deck bundles.

The bundles must be rigged for lifting so that shifting and excessive tipping will not occur and so the lifting device will not damage the deck (see Figure 3). All lifting equipment must be adequate for the job. The hoisting operation must be properly directed and manned. Tag lines attached to the bundles (not to the bands) will help workers control and position the load. Never move bundles by pulling on the strapping. (See Section V on Unloading). If possible, spread deck bundles out along the building column lines to create several small stacks rather than stacking all the bundles in one area. Workers should be instructed to keep the load in sight until it is safely placed on the structure. Bundles should be landed so that the ends of the bundles rest on a bearing surface rather than having one or both ends cantilevered. The bundles should be positioned for convenient spreading of sheets and oriented so individual deck sheets will not need to be turned. Bundles of deck which have been unbanded must be secured to prevent individual sheets from being blown off the structure.

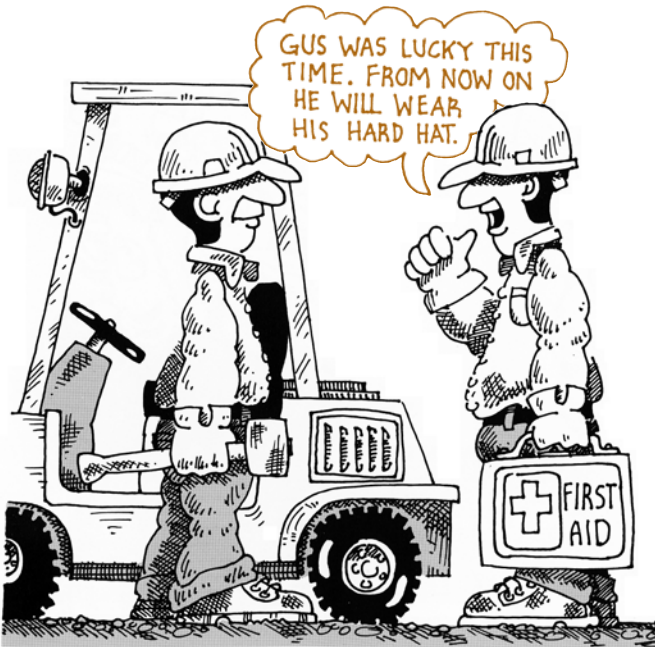

EXAMPLE OF ONE LIFTING METHOD
Figure 3

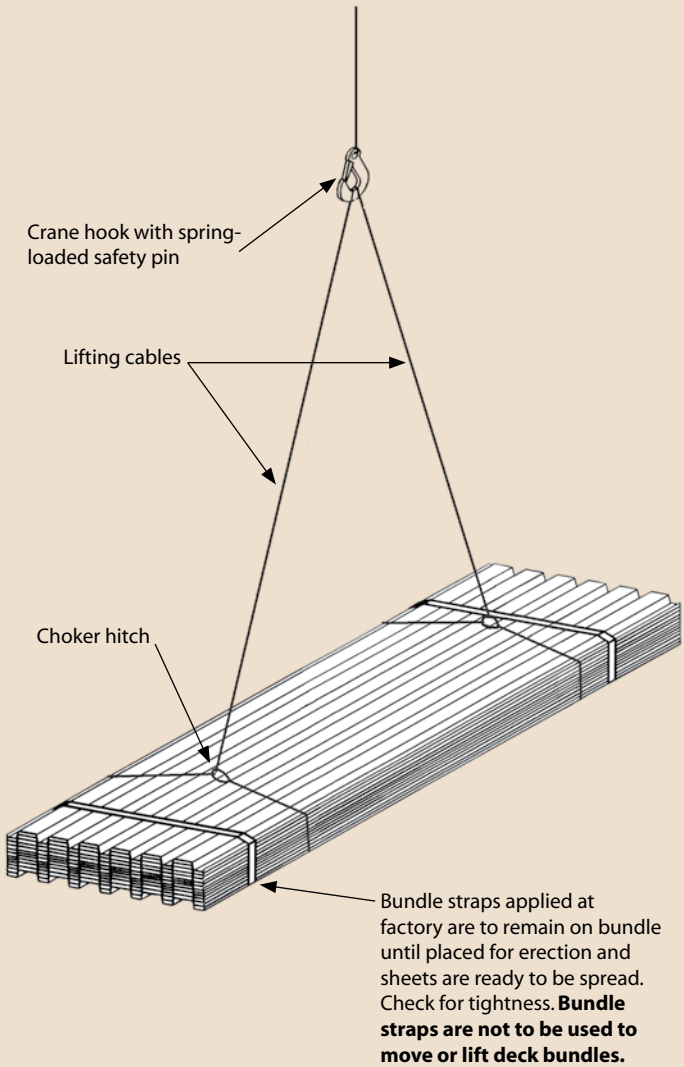

Safe Working Platform

To make the working platform safe and prevent deck damage, the deck units should be attached to the frame and side laps connected as soon as possible. If deck sheets are temporarily used to access bundles, they must be end bearing (not cantilevered) and must be securely attached to the frame to prevent slip off. A working area should be at least 12 feet wide. It is recommended that a working area be established around or along each bundle so that the bundle can safely be accessed. The platform can then be extended in any convenient direction. Specific job requirements need to be considered to determine deck erection starting points and erection progression. As the platform is extended it will be necessary for at least one worker to work from the structural frame. OSHA standards require that employers provide fall protection during deck erection operations and all OSHA guidelines for safety while erecting deck must be followed. Refer to OSHA Regulation 29 CFR Section 1926.759(c)(2003) which states that under special circumstances a Controlled Deck Zone (CDZ) may be established which permits flexibility to the methods of personal fall protection.

“ PLACE HEAVY LOADS OVER MAIN SUPPORTS ”

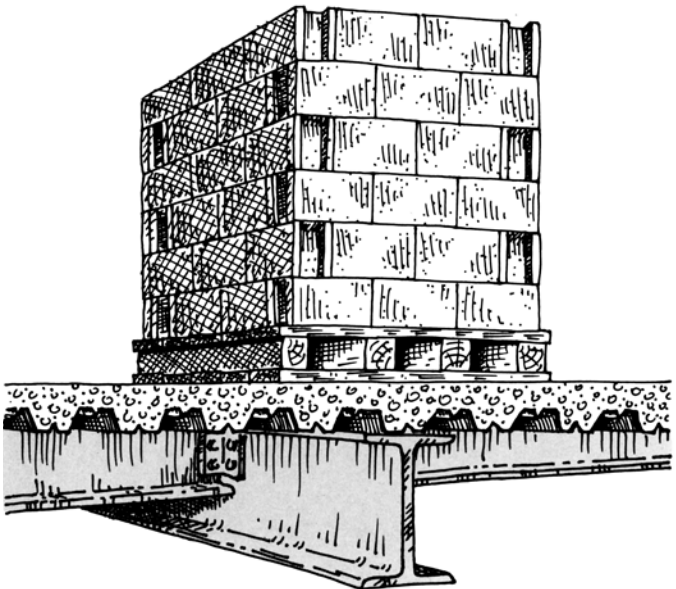

Placing Deck

As the deck sheets are placed, one edge of deck will always be “open” or leading. This leading edge should only be approached in order to place the next sheet. Workers should also maintain a safe distance (6 feet if possible) from the end of the deck unit. When aligning the edge (side) lap, the worker should kneel. Kneeling lowers his center of gravity and decreases the chance of falling. Refer to OSHA Regulation 29 CFR Section 1926.759 (a)(1)(2003) which states that under special circumstances a Controlled Deck Zone (CDZ) may be established which permits flexibility to the methods of deck installation.

Roof and floor holes and openings shall be decked over, unless the size of the hole or special design circumstances prevent it from being decked over. It is the responsibility of the design professional to define whether a hole is required to be decked over. Where large size holes or other conditions that do not allow an opening to be decked over, employees shall be protected in accordance with OSHA Regulation 29 CFR Section 1926.760 (a)(1)(2003).

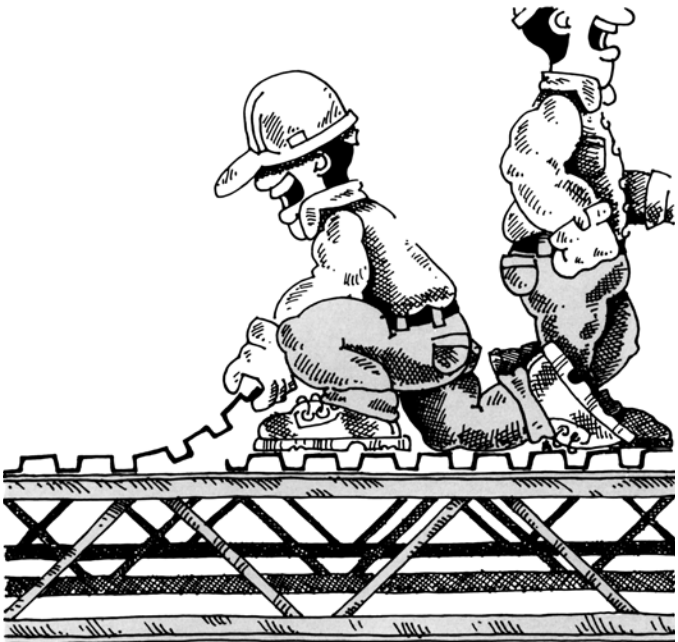

Other Trades

Other trades should be kept off the working platform and the area immediately below the working platform during the deck erection process. Care must be taken when cutting bundle straps to prevent straps or dunnage from dropping onto personnel or equipment. Workers should be instructed on all aspects of deck safety before any deck is installed. Such instruction is available to members on request from the Iron Workers International Association (AFL-CIO) by contacting a local union training coordinator. Non-union sources may also be available.

Floor deck should be selected so that it provides at least fifty pounds per square foot capacity as a working platform. If temporary shoring is required to attain fifty pounds per square foot, then the shoring must be securely in place before the floor deck erection begins. The fifty-pound per square foot loading does not consider concrete weight. See Figure 16 for recommended loading of the deck as a concrete form.

Roof deck is not generally required to carry as much foot traffic as floor deck, but at least thirty pounds per square foot should be made available by roof deck. If the roof deck being used does not provide a platform capacity of 30 psf, then it should be planked or supported during erection. Areas subject to traffic or material staging should be planked. The maximum recommended spans for roof decks (see Figure 15) should also be used as a guide.

A steel deck surface is inherently slippery when wet. Caution is required by anyone on the deck when this condition exists.

Figures 15 & 16 are on pages 46 & 47 respectively

1. Make sure that rigging is adjusted to keep hoisted loads well balanced.
2. Do not stand under loads being hoisted.
3. Keep loads in view.
4. Use proper hand signals to crane operators.
5. Check erection drawings to land deck in proper position and orientation to avoid turning deck.
6. Make sure bundles are secure and stable before cutting bands.
7. Pay particular attention to single span bundles.
 - a. Do not use single span bundles as a working platform, especially to cut bands.
 - b. Sheets could shift due to handling. Ensure bottom sheet extends past the support at both ends, otherwise place where full support can be obtained.
8. When cutting bands on bundles use both hands and stand well back - bands are under tension. Eye protection is recommended.
9. Pay special attention to short units or single span units— make sure deck is firmly secured before using it as a working platform.
10. Make sure cut outs and openings are adequately supported and guarded.
11. Use chalk lines to locate supporting steel - measure accurately.
12. Be alert for sharp edges.
13. Wet deck is inherently slippery - watch your footing.
14. Keep a litter free work place.
15. Wear eye protection when near welding.
16. When installing galvanized deck on sunny days, sunglasses and sunburn protection are advisable.
17. Stay alert.

Fastening and Installing Deck

Deck is installed in accordance with the “Approved for Construction” drawings. The deck must be installed by qualified and experienced workers. The beginning point should be carefully selected for proper deck orientation and edge of roof or floor slab location.

Maintaining rib or flute alignment across the structure is very important. A snap chalk line should be used at reasonable intervals to assure proper alignment of deck panels. Panel cover widths must be maintained to achieve long straight runs of deck.

Roof deck is often left exposed on the bottom. Rib alignment must be parallel to the girders at all girder lines to prevent unsightly conditions.

Floor deck flutes should, if possible, maintain alignment to achieve continuous concrete ribs across abutting sheet ends, minimizing concrete leakage. Flutes that do not align can create closure problems that may interrupt the slab design. Proper alignment can only be achieved by proper adjustment of each deck panel as it is placed. Cover width errors accumulated across the bay cannot be corrected with the last sheets in the run.

On-site experience has demonstrated that the frequency of snapping a chalk line determines the accuracy of rib and flute alignment. This minor effort at the time of deck placement eliminates the need for field corrections.

For deck to perform its design functions and serve as a working platform, it must be adequately and properly attached. Often the deck is used as part of the horizontal bracing system and the fastening method and pattern have been selected to provide a certain strength and stiffness in the plane of the deck.

NO SUBSTITUTION of fastener type or pattern should be made without the approval of the designer.

Deck fastening to the structural frame can be accomplished with welds, self drilling screws, air driven, or powder driven fasteners. A minimum of 1 ½” of end bearing should be provided for deck. If there is less than 1 ½” of bearing, additional fastening should be provided and the deck end load capacity should be checked. For deck that is intended to end lap (roof deck), the end lap location should be adjusted so the center of the lapped portion occurs over the support or, when supported by bar joists, over a top chord member.

Only qualified operators may use powder actuated tools; air actuated tools must be used by trained operators familiar with all safety procedures.



Example of Overlapping

SIDE LAP CONNECTIONS
Figure 6

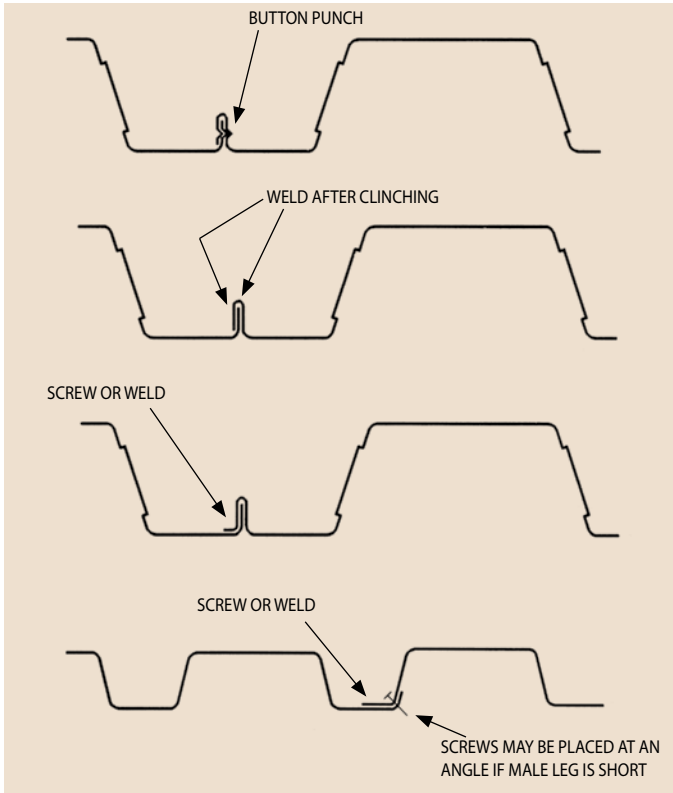

Attaching

Special electric screw guns are used to drive self-drilling screws to attach deck to the structural frame. These screw guns are equipped with a clutch and depth limiting nosepiece to prevent over torquing. Screws are typically #12's or 1/4 inch diameter with a special drill point selected according to the total thickness of metal (deck plus frame) being joined.

Air driven tools are operated at a pre-set pressure level consistent with the fastening requirements of the deck attachment. Air is supplied by a compressor equipped with a regulator that prevents over-driving or under-driving the fastener. The fasteners have a flat head at the drive end and a ballistic point at the penetrating end. A variety of sizes are available to meet the penetration requirements of the steel substrate.



Powder Actuated

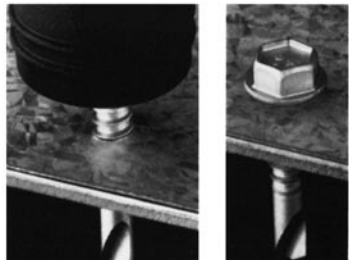

Self Tapping/Drilling

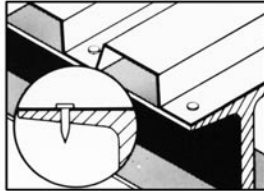
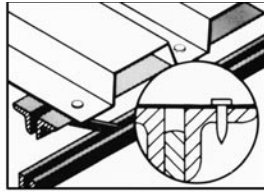

Air Driven/Pneumatic

Welding

Welding must be done by a qualified welder during proper weather conditions. Quality welding of light gage deck requires experience and the selection of proper amperage and electrodes. A weld quality control test procedure is shown in Figure 7. All welding should be done in accordance with the Structural Welding Code, AWS D1.1 or D1.3. Weld washers are not recommended for deck thicknesses of 0.028 inches thick (minimum 22 gage) and greater. Weld washers are recommended for metal thicknesses less than 0.028 inches. Proper welding requires good metal to metal contact; therefore, lapping composite deck units with shear lugs is not recommended. For the same reason, built in hanger tabs (in floor deck) that bear on structural steel should be flattened or removed.



WELD QUALITY CONTROL TEST PROCEDURE

Figure 7

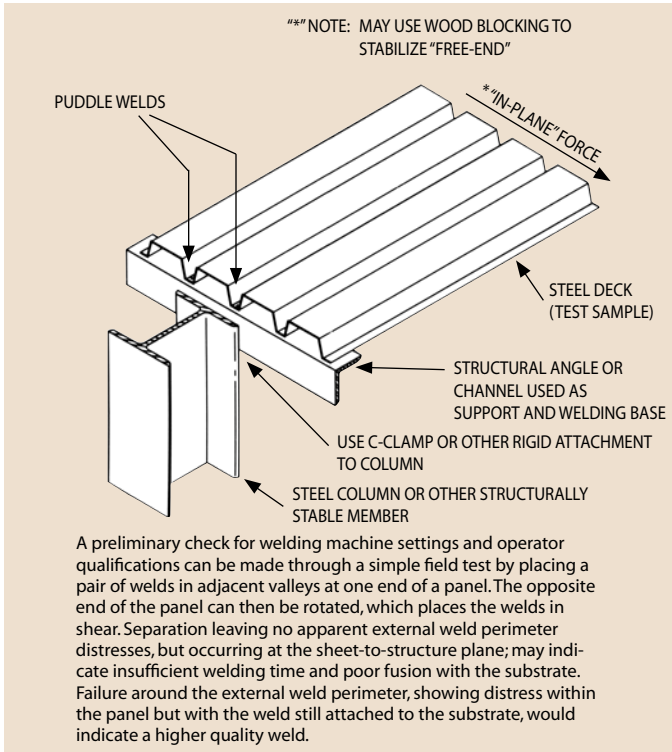

Shear Studs

Shear studs, welded in place with special equipment (in accordance with AWS D1.1) can serve as welding to hold the deck to the frame. These studs are usually installed after the deck has been spread to act as a working platform. Therefore, it is necessary that the platform be adequately attached to the structure before the studs are installed.

Shear studs can be welded through the double metal thickness of cellular deck. Note: If the deck is heavier than 16 gage the stud manufacturer should be consulted for installation procedures. Shear studs, like all other fasteners, must be installed in accordance with the design drawings.

Since most construction work is done in open air, ventilation for welding is usually adequate. However, for closed in areas, ventilation must be provided. Adequate ventilation is extremely important when welding galvanized deck. All workers involved in the welding operation must wear eye protection to avoid weld flash.



Welding should not be done near any type of combustible material. Cutting and welding sparks can cause construction fires. Conditions at a construction site are subject to rapid change. Welding may be safe in a given area and then, because combustibles are introduced, the area is suddenly not safe.

The General Contractor (job supervisor) should prevent other trades from storing combustibles near or under areas where welding is to be done. Constant alertness in and below the general area is mandatory.

“DO NOT WELD NEAR COMBUSTIBLES”



Side Lap Connections

Sheet to sheet connections may be required at the side laps of deck. These are frequently referred to as stitch connections. Self drilling screws, welds or button punches are the usual stitch connections. Stitch screws are usually self drilling type; #8's through 1/4 inch diameter can be used but screws smaller than #10 diameter are not recommended. The installer must be sure that the underlying sheet is drawn tightly against the top sheet. Again, as when screws are used as the frame attachment, the special screw driving guns are used to prevent over torquing.

Manual button punching of side laps requires a special crimping tool. Button punching requires the worker to adjust his weight so the top of the deck stays level across the joint. Since the quality of the button punch attachment depends on the strength and care of the tool operator, it is important that a consistent method be developed. Automatic power driven crimping devices are rarely seen on deck jobs but should not be ruled out as a fastening method.

Good metal to metal contact is necessary for good side lap welds. Burn holes are the rule rather than the exception and an inspector should not be surprised to see them in the deck. The weld develops its strength by holding around the perimeter. A good weld will have 75% or more of its perimeter working. On occasion, side lap welds will be specified for deck that has the button punchable side lap arrangement (see Figure 8 for comments on this subject; see Figures 8 and 9 for welding these deck units to the frame). Welding side laps is not recommended for decks type 22 (0.028 inch minimum) or lighter. Weld washers should never be used at side laps between supports. Just as when welding to the frame, adequate ventilation must be available and welding near combustibles prohibited.

SIDE LAP WELDS BETWEEN SUPPORTS

Figure 8A

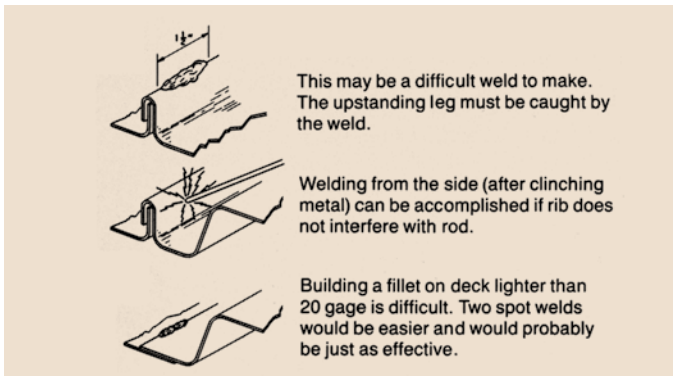

SIDE LAP WELDS AT SUPPORTS

Figure 8B

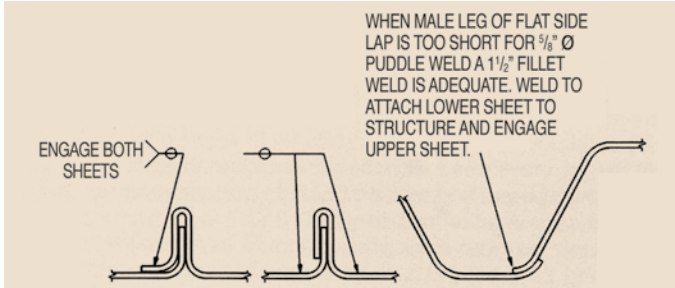

FRAME CONNECTION LAYOUTS

Connections may be arc puddle welds, screws, powder-actuated or pneumatically driven fasteners.

Figure 9

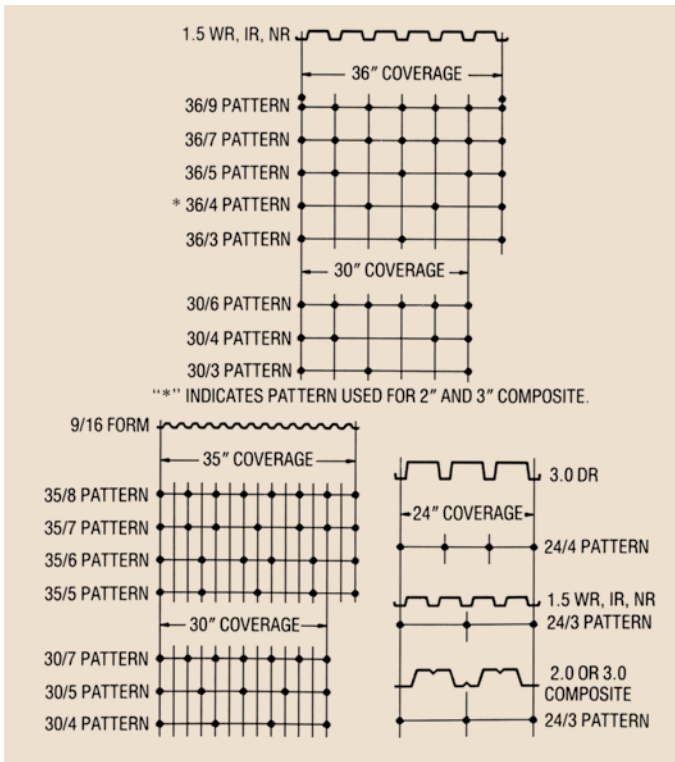

Housekeeping

Bundling straps, wood dunnage, and deck cut offs should be collected and removed from the working platform daily so as not to create a safety hazard underfoot. Loose tools should not be left lying about. Stud welding ferrules should be broken off of the studs. All debris must be removed from floor deck before concrete is poured.

All parties concerned with the construction process should cooperate to properly store combustible material and remove trash that can be a fire hazard.

Absolutely no loose deck sheets should be left at the end of the working day. Any partially used bundles must be tightly secured to prevent blow off.

**“CLEANING IS EASIER
THAN RECUPERATING”**



Damage to deck and purposeful penetrations have much in common: their location and severity are seldom known beforehand. Usually the design professional knows the general area where a vent stack may cut the roof, or approximately where a telephone conduit may pierce the slab; but he may not know how big the hole will be. This lack of information makes it difficult to advise how holes should be reinforced, if at all, or how damaged deck should be repaired. Guide specifications reflect this lack of specific knowledge. The SDI Specification states, "Openings not shown on the erection diagrams, such as those required for stacks, conduits, plumbing, vents, etc., shall be cut (and reinforced, if necessary) by the trades requiring the openings." The design professional should be consulted for reinforcing requirements, but frequently, unless details are shown on the plans, no deck reinforcing is provided and the design professional is not consulted.

Deck damage presents similar problems. Broad statements such as, "All damaged deck must be replaced," can be made. The design professional must then make the decision as to what constitutes damaged deck while considering how replacement may delay the job. How much damage can be tolerated depends on architectural and structural considerations. If the underside of the deck is exposed to public view, very little visible damage may be allowed. In most cases, however, the deck will be hidden by a ceiling or ducts and utilities and the usual concern is about structural performance.

Roof Deck

For most 1½" roof decks the loss of one rib per sheet, either by denting or penetration, can be tolerated. No reinforcing is generally required for an opening of 6" as long as not more than two webs are removed. In most cases the capacity of the deck is greater than required for roof loads. One six inch diameter hole per sheet in a span should not adversely affect the diaphragm strength and a dent can be larger than 6" and still carry the horizontal load. Covering a dent or an 8" maximum hole with a 0.045" plate and extending the plate to adjacent ribs could eliminate worries about insulation board spanning the dent and about a "soft spot" in the roof. For holes or dents greater than a rib (8" to 13"), it is advisable to use a 0.057" minimum plate. Exceptions to this recommendation are:

1. the hole may be located in such a place that the deck can safely cantilever from each adjacent support;
2. a group of holes may be so close together that a structural frame is required.

DECK DAMAGE AND PENETRATIONS

EXAMPLE OF 6" PENETRATION

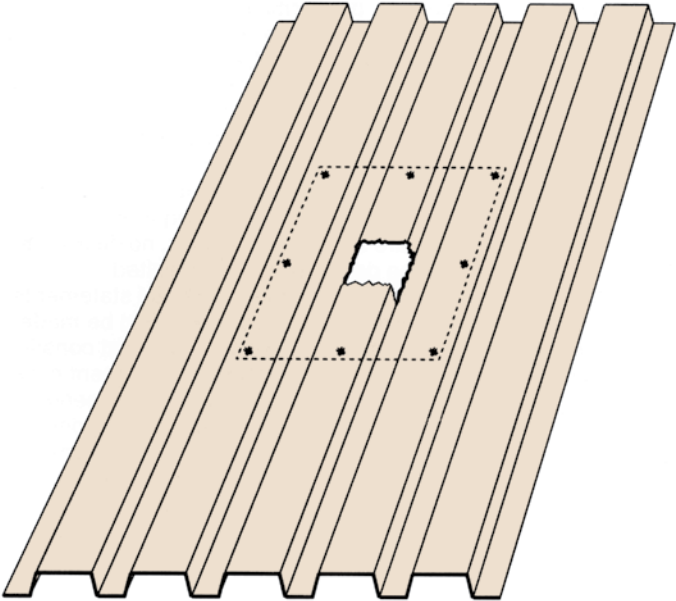

SUGGESTED SCHEDULE:

One Rib Removed (6" Diameter)	No Reinforcing Or 0.045" Plate (Min.)
8" Diameter	0.045" Plate (Min.)
8" to 13" Diameter	0.057" Plate (Min.)
Over 13"	Frame Opening* (Design By Project Engineer)

*Check cantilever ability of deck

EXAMPLE OF DETAILS FOR OPENINGS

DETAILS FOR OPENINGS TO 24" PERPENDICULAR TO DECK

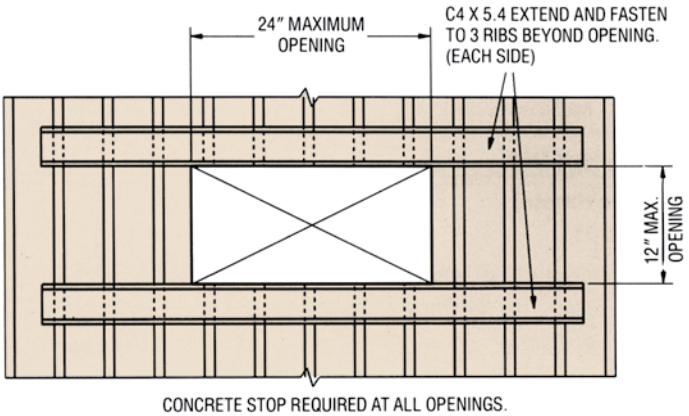

DETAILS FOR OPENINGS TO 12" PERPENDICULAR TO DECK

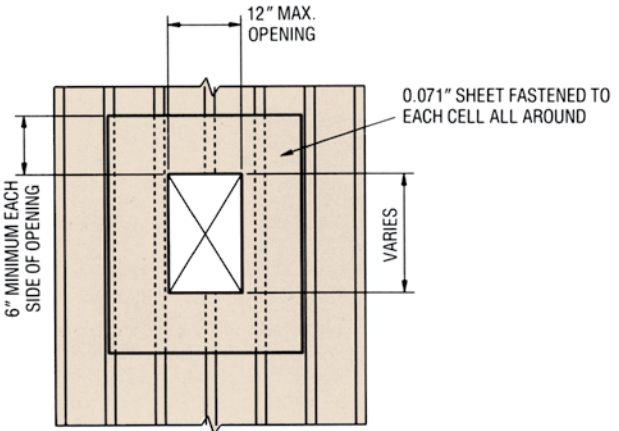

Note:

For holes 6" Ø or less no reinforcing or minimum 0.045" plate required, depending on location.

SUMP REINFORCING AT END OF DECK

Figure 12

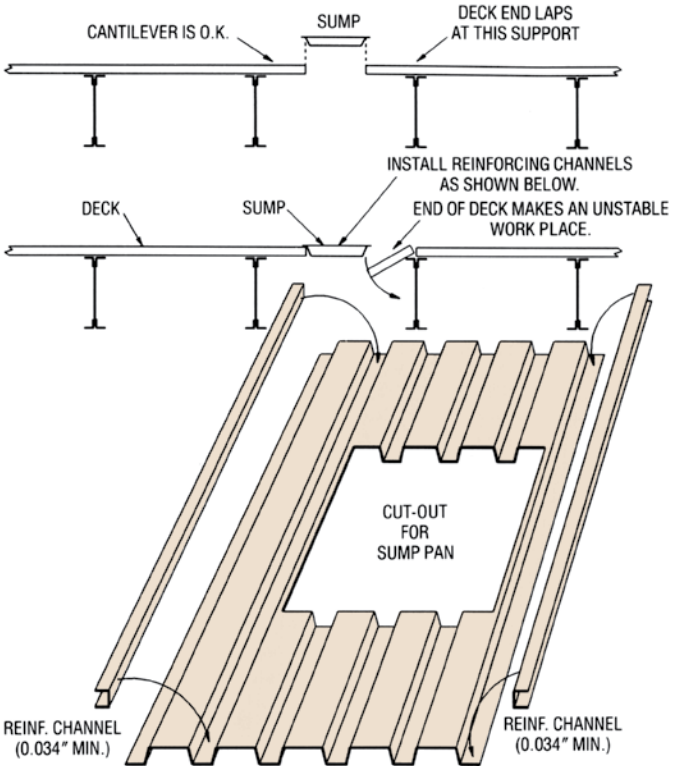

Put 1-1/2" deep reinforcing channels in each rib at each side of opening (flush with top of deck). Channels span between joists. Attach flanges of sump pan to channels.

Burn holes in deck side laps, caused by welded side lap attachments, are spaced far enough apart not to cause problems. Burn holes near intermediate supports are unlikely to cause much loss of strength unless a total area greater than a 6" diameter hole is removed. These burn holes are usually caused by the welder searching for the unseen structural member; therefore the use of chalk lines is recommended.

Distributed small dents, such as those caused by foot traffic, will not cause a structural problem; but if the denting covers a large percentage of the job, the insulation board will be better attached with mechanical fasteners rather than by adhesives. The design professional must approve any change in fastening.

Vigilance should be maintained to detect and correct any "soft" spots in roofs that could cause insulation boards to crack under foot loading.

Floor Deck

Before concrete is poured, the contractor should inspect the deck to find any areas that may be damaged or crushed which may require shoring for the concrete pour. Areas that buckle during the pour are usually caused by previous damage, over spanning the deck, or allowing concrete to pile up. Buckled areas do not adversely affect the live load capacity. Tests at West Virginia University, by Dr. Larry Luttrell, showed no loss in live load capacity when the deck was purposely buckled.

Since floor deck damage or penetration can affect the deck's capacity to carry concrete, any floor deck damage or penetration must be evaluated prior to pouring concrete. Floor deck, like roof deck, can be examined as a cantilever. However the SDI does not publish a cantilever table for floor deck because of the great profile variations available. A method for calculating allowable cantilever spans is shown in Figure 13. A preferred forming method is to block out concrete from where a penetration will occur; and, after the concrete sufficiently cures, burn the deck away. The design professional determines the need for additional bars or mesh around the block out.

It is the responsibility of the design professional to designate holes/openings to be decked over in compliance with OSHA Regulation 29 CFR Section 1926.754(e)(2)(2003). When a hole/opening is not shown and dimensioned on the structural design drawings, no provisions for concrete retainage will be provided. When a framed hole/opening is shown and dimensioned on the structural design drawings in floor deck, pour stop (screed) angle will be provided from the top of the deck to the top of slab only. Cell closures will be provided in the strong dimension in standard 10'-0" lengths to be field sized, cut and installed as shown in Figure 14. Do not field cut deck at holes/openings until concrete has reached 75% of its design strength (minimum of seven (7) days in most cases).

The deck should be inspected for adequate attachment at supports and at side laps. Side laps must be tightly connected to prevent opening during concrete pouring.

Concrete provides an alkaline environment that discourages corrosion. Since most applications of composite deck are in dry interior areas, field painting of burned, cut or abraded areas is not usually required. Any touch up requirements must be provided in the job specifications since the design professional establishes the deck finish required for the environment.

MAXIMUM FLOOR DECK CANTILEVERS

Figure 13

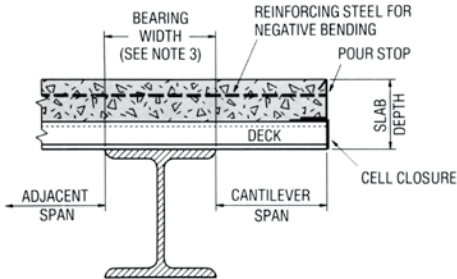

NOTES:

- 1) Allowable bending stress of 20 ksi with loading of concrete + deck + 20 psf, or concrete + deck + 150 lb. concentrated load, whichever is worse.
- 2) Allowable deflection of free edge (based on fixed end cantilever) of 1/120 of cantilever span under loading of concrete + deck.
- 3) Bearing width of 3-1/2" assumed web crippling check - concrete + deck + 20 psf over cantilever and adjacent span. If width is less than 3-1/2" check with the deck manufacturer.

STANDARD ACCESSORIES AT DECKED OVER OPENINGS

Figure 14

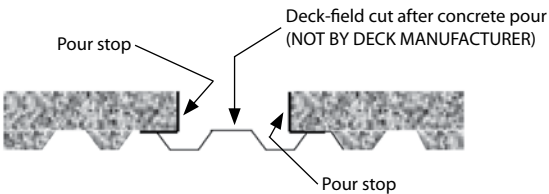

**TYPICAL DETAIL @ ANGLE FRAMED
OPENING**

(DECK IN WEAK DIRECTION)

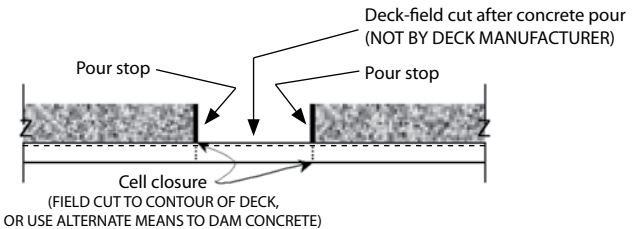

**TYPICAL DETAIL @ ANGLE FRAMED
OPENING**

(DECK IN STRONG DIRECTION)

VIII. PLACING CONCRETE

After the floor deck (or form deck) has been properly installed, it acts as a working platform for many trades. The deck should have been selected to provide at least fifty pounds per square foot capacity as a working platform. If the contractor anticipates loads on the platform that will exceed 50 psf, he should take appropriate steps to ensure the deck will carry the load.

Before concrete is poured, the contractor should make sure that the deck is properly and completely fastened in accordance with approved deck erection drawings and the deck has adequate bearing on all supports. Damaged areas must be repaired or accepted. All ferrules should have been broken off the studs. All dirt and debris must be removed. All reinforcement, wires or rods, should be securely in place. The concrete contractor should review the deck shoring requirements and make sure that shores are securely in place.

Concrete should be poured from a low level to avoid impacting the deck. It should be placed uniformly over the supporting structure and spread towards the center of the deck span. Concrete should be placed in a direction so that the weight is first applied to the top sheet at the side lap, reducing the possibility of the side opening during the pour. Workers should not congregate around the concrete placement zone. If buggies are used to place the concrete, runways should be planked and the buggies should only operate on the planking. The planks should be stiff enough to transfer the buggy loads without damaging the deck. Deck damage caused by roll bars or careless placement must be avoided.

For calculating deck stresses and deflections during concreting the SDI loading schedule as shown in Figure 16 is recommended. This method of analysis has been in use for many years and has provided good results. Because pouring room can be restricted, special consideration is required for single span conditions. For example, a single span condition commonly occurs between elevator shafts, and it is likely that concrete placement will be less controlled. A 50% factor is then added to the concrete weight and a deck gage selected is based on this loading. As an alternative, shoring may be specified. Although deck connections are important for all span conditions, they are extremely important for single spans. Connections should be thoroughly checked.

As concrete is placed, the entire frame as well as the deck will deflect. Concrete quantities should be calculated with all deflections taken into account. The weight of concrete finishing equipment will also affect the capacity of the deck as a working platform. For example, heavy equipment suitable for use to finish slabs on grade will generally not be suitable to finish elevated concrete slabs supported by steel deck.

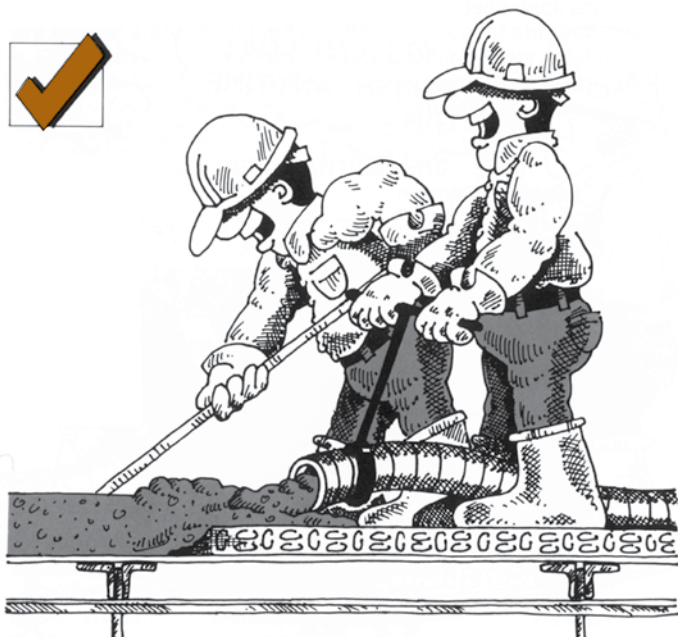

PLACING CONCRETE

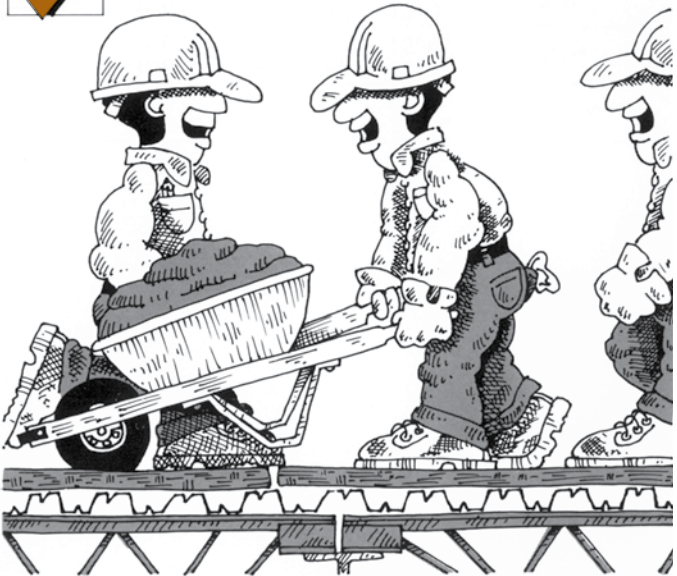
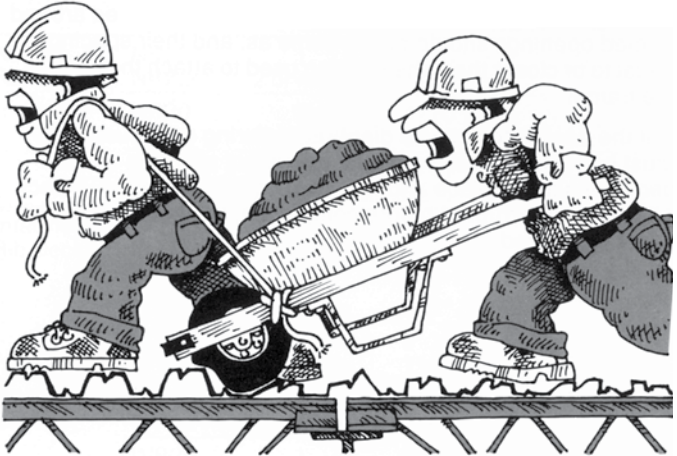

When the deck has been designed to act as a shear diaphragm, it should be noted on the record drawings. The note should caution that the deck panels act as bracing for the building and that removing any of the panels is prohibited unless separate bracing is designed and provided. Deck fasteners used around framed openings should be the same as, and their spacing equal to or closer than, the fasteners used to attach the deck to the frame.

If the deck is to act as a diaphragm during construction, it must be realized that the diaphragm is not effective until all deck units are in place and fully connected. Therefore, if deck erection is interrupted before completion, temporary bracing may be required.

Figure 15

CONSTRUCTION LOAD TABLE

Recommended Maximum Spans for Construction and Maintenance Loads Standard 1 ½" and 3" Roof Deck				
	Type	Span Condition	Span Ft.-In.	Maximum Recommended Spans Roof Deck Cantilever
Narrow Rib Deck	NR22	1	3'-10"	1'-0"
	NR22	2 or more	4'-9"	
	NR20	1	4'-10"	1'-2"
	NR20	2 or more	5'-11"	
	NR18	1	5'-11"	
NR18	2 or more	6'-11"	1'-7"	
Intermediate Rib Deck	IR22	1	4'-6"	1'-2"
	IR22	2 or more	5'-6"	
	IR20	1	5'-3"	1'-5"
	IR20	2 or more	6'-3"	
	IR18	1	6'-2"	
IR18	2 or more	7'-4"	1'-10"	
Wide Rib Deck	WR22	1	5'-6"	1'-11"
	WR22	2 or more	6'-6"	
	WR20	1	6'-3"	2'-4"
	WR20	2 or more	7'-5"	
	WR18	1	7'-6"	
WR18	2 or more	8'-10"	2'-10"	
Deep Rib Deck	3DR22	1	11'-0"	3'-6"
	3DR22	2 or more	13'-0"	
	3DR20	1	12'-6"	4'-0"
	3DR20	2 or more	14'-8"	
	3DR18	1	15'-0"	
3DR18	2 or more	17'-8"	4'-10"	

DECK LOADING DIAGRAMS

Bending Moments — Deflections — Support Reactions Figure 16

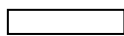

concentrated man
or equipment load
(150 lbs./ft. of
width unfactored)

uniform concrete
load

 clear span

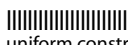
uniform construction
load (20 psf,
unfactored)

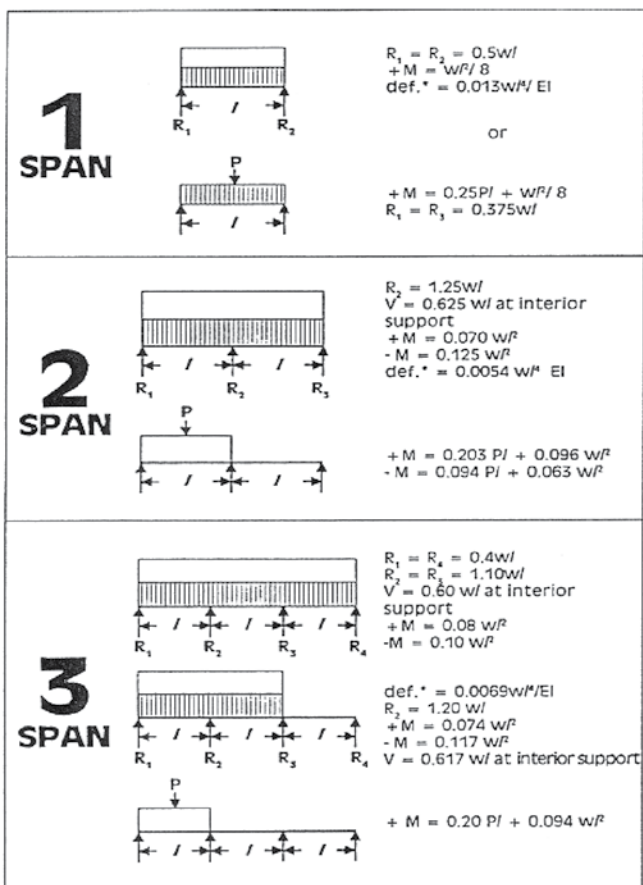

For single spans only, the concrete load shall include either an additional 50% of the concrete weight or 30 psf whichever is less
 * Deflection is to be calculated using only concrete plus deck weights uniformly distributed over all spans.

1. *Design Manual for Composite Decks, Form Decks and Roof Decks*, Publication No. 30, Steel Deck Institute, Fox River Grove, Illinois.
2. Luttrell, L.D. and Ellifritt, D.S., "The Strength and Stiffness of Steel Deck Subject to In-Plane Loading," Report No. 2011, Department of Civil Engineering, West Virginia University, 1970.
3. *Steel Deck Institute Diaphragm Design Manual, DDM03*. Third Edition, September, 2004, Steel Deck Institute, Fox River Grove, Illinois.
4. "Preventing Damage to Buildings Under Construction", 1988 Factory Mutual Approved Product News, Factory Mutual Research, Norwood, Massachusetts.
5. "Fall Protection for Deck Installation", Construction Safety Association of Ontario, Toronto, Ontario, Canada.
6. "Standard for Steel Roof Deck", Canadian Sheet Steel Building Institute, Willowdale, Ontario, Canada.
7. Heagler, R.B., Luttrell, L.D., "How to Fasten Steel Deck - Update and Review", Modern Steel Construction Number 1, 1988, American Institute of Steel Construction, Chicago, Illinois.
8. 29 CFR Part 1926 Safety Standard for Steel Erection, Final Rule, OSHA/U.S. Dept. of Labor 2001, Washington, D.C.
9. "Handling and Erection of Steel Joists and Joist Girders", Technical Digest No. 9- March, 2006, Steel Joist Institute, Myrtle Beach, South Carolina.
10. *Cold Formed Steel Design Manual*, 2002 Edition, American Iron and Steel Institute, Washington, D.C.
11. *Manual of Steel Construction*, Thirteenth Edition, American Institute of Steel Construction, Inc., Chicago, Illinois.
12. Yu, W.W., *Cold Formed Steel Design*, 2000, John Wiley and Sons, New York, New York.
13. *Fire Resistance Directory*, 2006, Underwriters Laboratories, Inc., Northbrook, Illinois.
14. *2006 Approval Guide*, Factory Mutual System, Norwood, Massachusetts
15. "Loss Prevention Data 1-28", 2005, Factory Mutual System, Norwood, Massachusetts.
16. NFPA. 51B, Standard for Fire Prevention in use of Cutting and Welding Processes, National Fire Association, Quincy, Massachusetts.
17. Heagler, R.B., "Metal Deck and Concrete Quantities", Steel Deck Institute, Fox River Grove, Illinois.
18. *Structural Welding Code—Steel*, ANSI/AWS D1.1-2006, American Welding Society, Miami, Florida.
19. *Structural Welding Code—Sheet Steel*, ANSI/AWS D1.3-98, American Welding Society, Miami, Florida.

Publication No. MOC2



STEEL DECK INSTITUTE
P.O. Box 25
Fox River Grove, IL 60021-0025
TEL: 847-458-4647
FAX: 847-458-4648
WEB SITE: <http://www.sdi.org>